

SPIT C9 - C9 strip - CR9

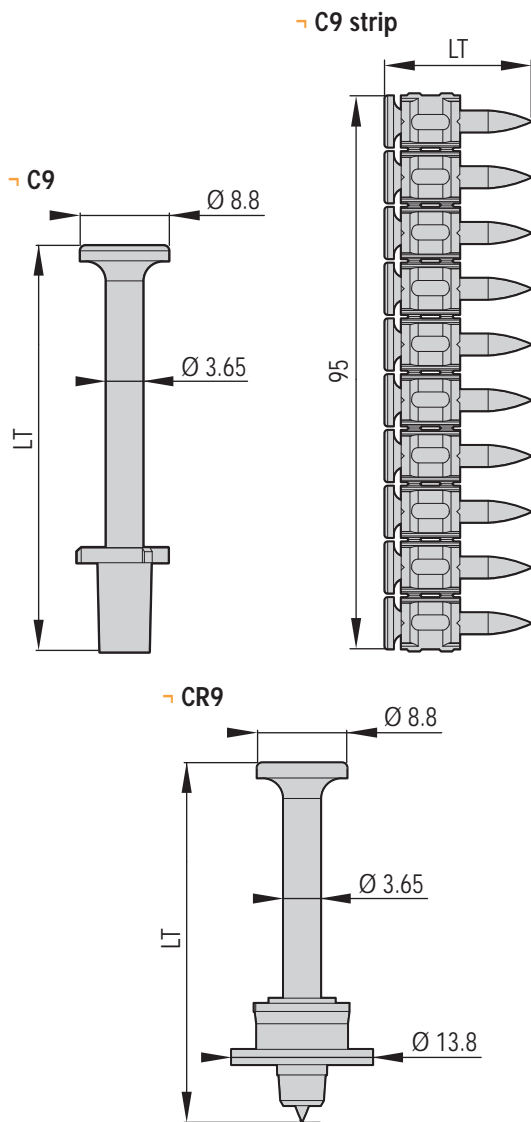



APPLICATION LIMIT

- For harder concrete > 25 Mpa, use the same setting and a shorter pin or SC9 with the same length.

CONTROL FIXING

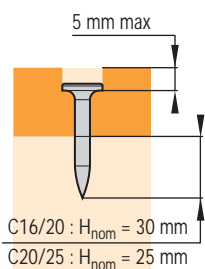
- Fixing of timber
- Embedment depth in base material



	$H_{nom}^{(1)}$ (mm)
 C16/20	30 - 35
 C20/25	25 - 30
C25/30	25 - 28

(1) indicative value

DESCRIPTION

- Timber to concrete
- Steel sheeting to concrete with a max thickness of 5 mm (except for CR9)
- The version CR9 with metallic washer allows to flatten in against wood, and to avoid wood splitting.

PROPERTIES MATERIAL

- Core hardness : 50-55 HRC
- Electrogalvanizing, min zinc coating 7 μ m
- Washer, electrogalvanizing (CR9)

TOOLS

P60 - P370



C9 strip only for P370 C60

ACCESSORIES

Accessories available, see the product catalogue.

NAIL LENGTH SELECTION

- Fixing of timber

C9 (C9-LT)	Thickness of timber		Code for C9 strip	Code for C9 loose	Code for CR9 R.14 loose
	 C16/20	 C20/25			
C9-20			011330	032740	-
C9-25			011331	032520	032070
C9-30		≤ 5	011332	032530	032100
C9-35	≤ 5	5 - 10	011333	032540	-
C9-40	5 - 10	10 - 15	011334	032550	032090
C9-50	15 - 20	20 - 25	011335	032560	032010
C9-55	20 - 25	25 - 30	011337	032210	-
C9-60	25 - 30	30 - 35	011336	032570	032020
C9-70	35 - 40	40 - 45		032580	032030
C9-80*	45 - 50	50 - 55		032590	
C9-90*	55 - 60	60 - 65		032600	

*Pre-drive before firing

RECOMMENDED LOAD

Base material	N_{Rec} (kN)	V_{Rec} (kN)
 Concrete C20/25	0.5	0.5

SPIT CR9TP - CR9P

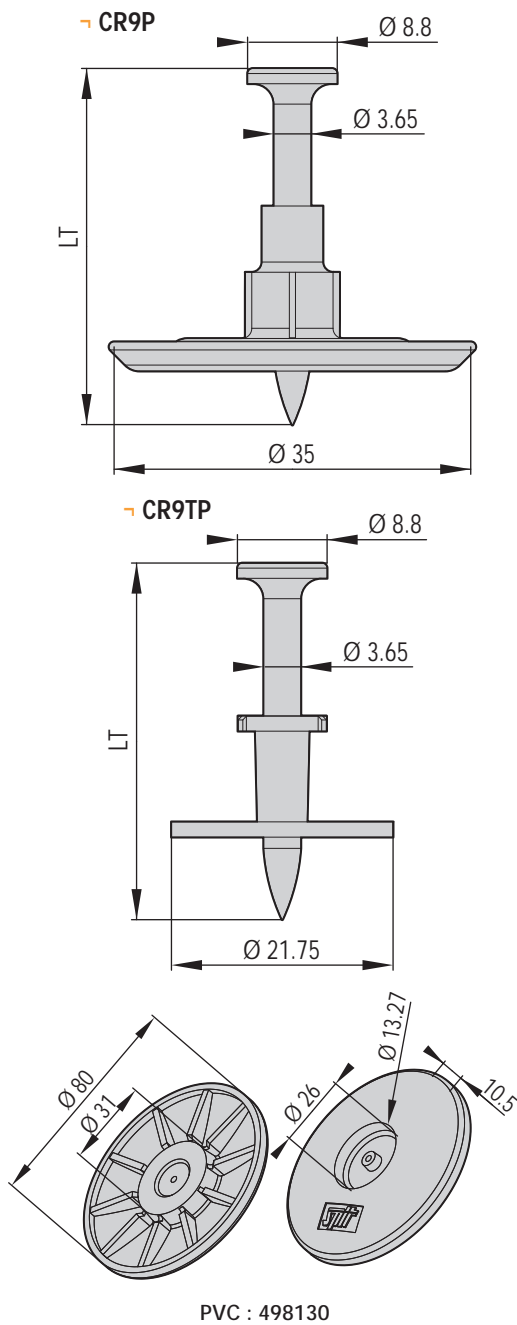

PVC : 498130

DENSITY FIXING

- 3 pins per m² for vertical installation.
- 5 pins per m² for ceiling installation.
- Maximum spacing between washer : 0.7 meter.

DESCRIPTION

- CR9P : Fastening of watertightness membranes
- CR9TP for PVC Washer (Ø80 mm) : using in tunnel for fastening of the geotextile for the waterdrainage. The layer is welded on the PVC washer.

PROPERTIES MATERIAL

- **Shank in carbon steel**
 - Hardness : 50 – 55 HRC
 - Electrogalvanizing, min zinc coating 7 µm
- **CR9P**
 - Plastic washer : Ø 35 mm
- **CR9TP**
 - Flat metallic washer
 - Ø 21.75 mm
 - Electrogalvanizing, min zinc coating 3 µm
 - Plastic tip for pin centering
- **PVC washer** for CR9T / CR9TP :
Ø 80 mm, thickness 10 mm

TOOLS

P60 – P370

CR9TP only for P45

NAIL LENGTH SELECTION

Designation	Ø washer	Code
CR9-35 TP	21.75	011321
CR9-40 TP	21.75	011322
CR9-30 P	35	038090
CR9-40 P	35	038100
CR9-50 P	35	038110